



## SCHEMATY/PATTERNS ***YOU CAN SLIDE 1***

Roleski Ranch Stare Żukowice 26-28.04.2019

### Reining

NRHA Open / AQHA & All Breed Senior Open	#12
NRHA Intermediate Open	#3
NRHA Limited Open	#8
NRHA Rookie Professional	#5
NRHA Non Pro / AQHA & All Breed Amateur	#10
NRHA Intermediate Non Pro	#4
NRHA Limited Non Pro	#6
NRHA Novice Horse Open lvl 2	#10
NRHA Youth 14-18	#8
AQHA & All Breed Youth 14-18	#7
NRHA Youth 13&Under	#8
AQHA & All Breed Youth 13&Under	(AQHA) #A
NRHA Youth Unrestricted	#6
NRHA Rookie lvl 1	#6
NRHA Rookie lvl 2	#6
NRHA SBH Open / AQHA & All Breed Junior Open	#5

### Reining Jackpot

???

AQHA & All Breed Ranch Riding Open	#5
All Breed Western Riding Open	#4

## Showmanship At Halter Youth & Amateur

AQHA

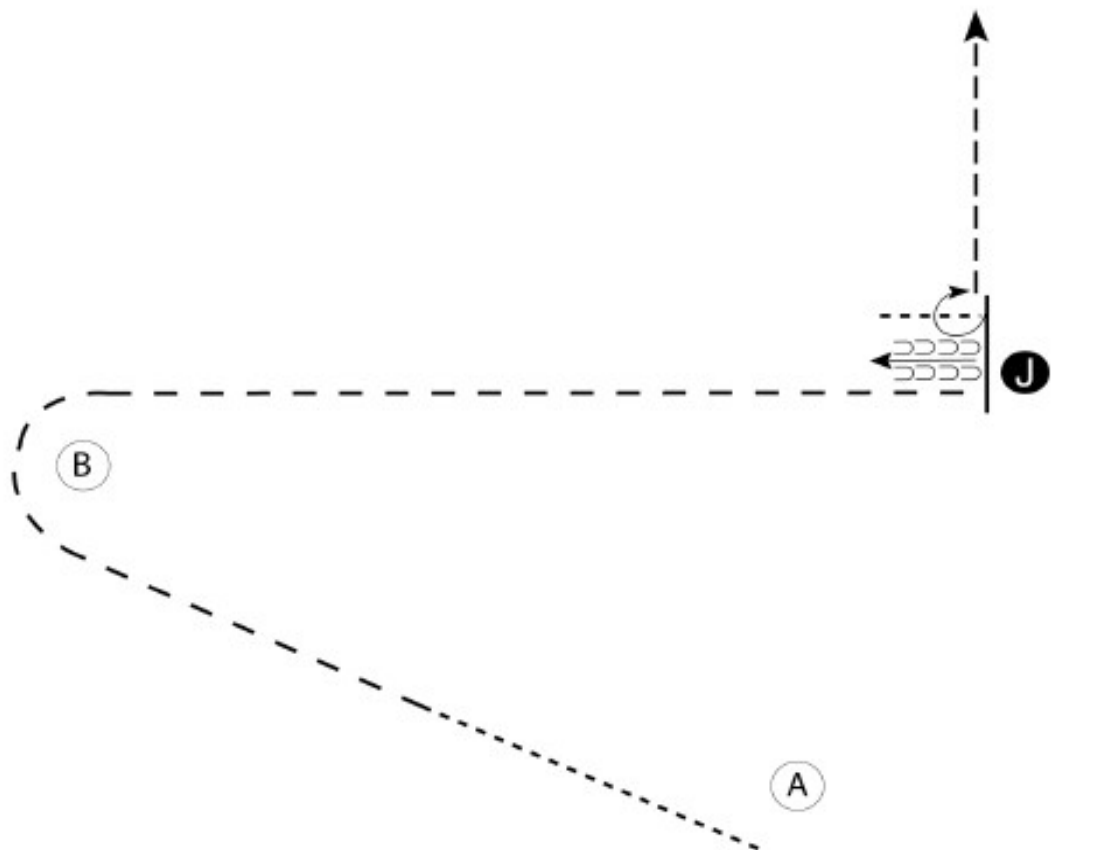

1. Begin at A. Walk halfway to B
2. Trot to and around B to the Judge
3. Stop and back one horse length
4. Walk to the Judge and set up for inspection
5. When dismissed perform a 270 degree turn and trot to the line-up

Walk	-----
Trot	—————
Back	←——— ←———
Marker	⊙ B
Judge	⊙ J

## Showmanship At Halter Open

All Breed

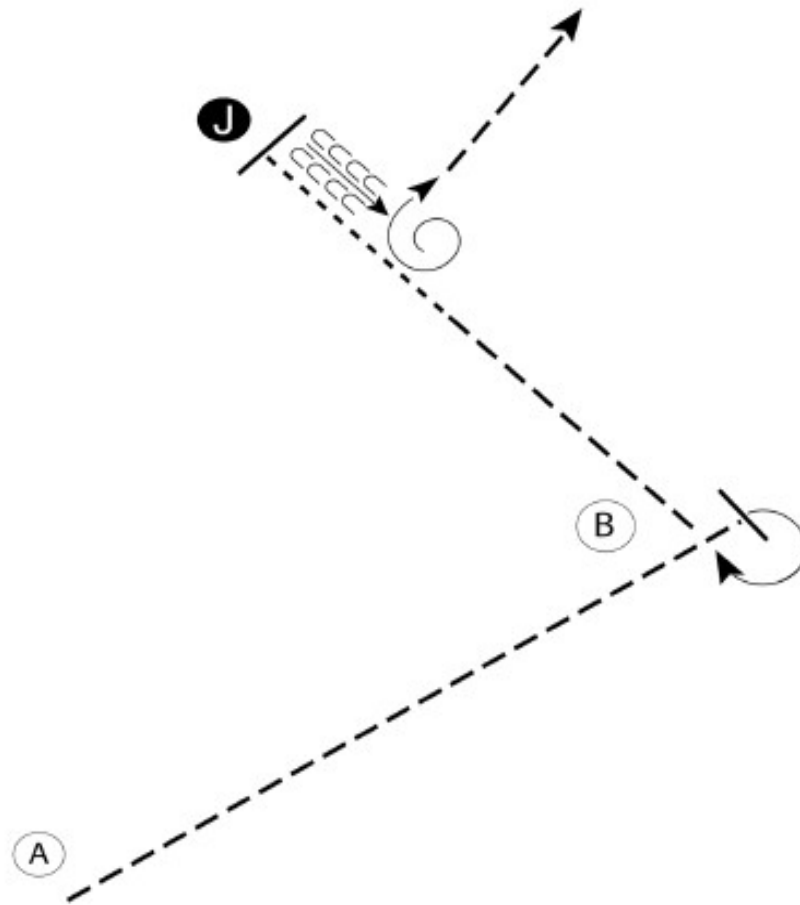

1. Begin at A. Trot past B and stop
2. Perform a 270 degree turn
3. Trot halfway to the Judge
4. Break to the walk and walk to the Judge
5. Stop and set up for inspection
6. When dismissed back one horse length
7. Perform a 450 degree turn and trot to the line-up

Walk	-----
Trot	- - - - -
Back	←
Marker	ⓑ
Judge	ⓐ

## Western Horsemanship Youth & Amateur

AQHA & All Breed

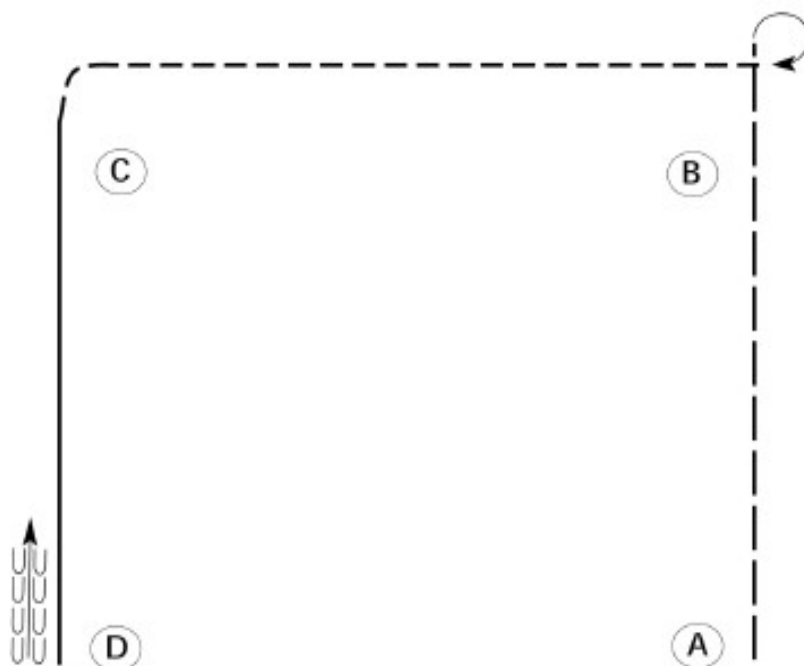

Be ready at A.

1. Extended jog from A to B.
2. Stop past B and execute a 270 degree turn to the right.
3. Jog from B around C.
4. Lope on the left lead from C to D.
5. Stop at D and back one horse length.

Please exit at a jog.

Walk	-----
Jog	- - - - -
Extended Jog	- - - - -
Lope	—————
Leg Yield	
Lead Change	↙ ↘
Back	←←←←← ←←←←←
Marker	(B)
Sidepass	←←←←←

## Western Horsemanship Open

All Breed

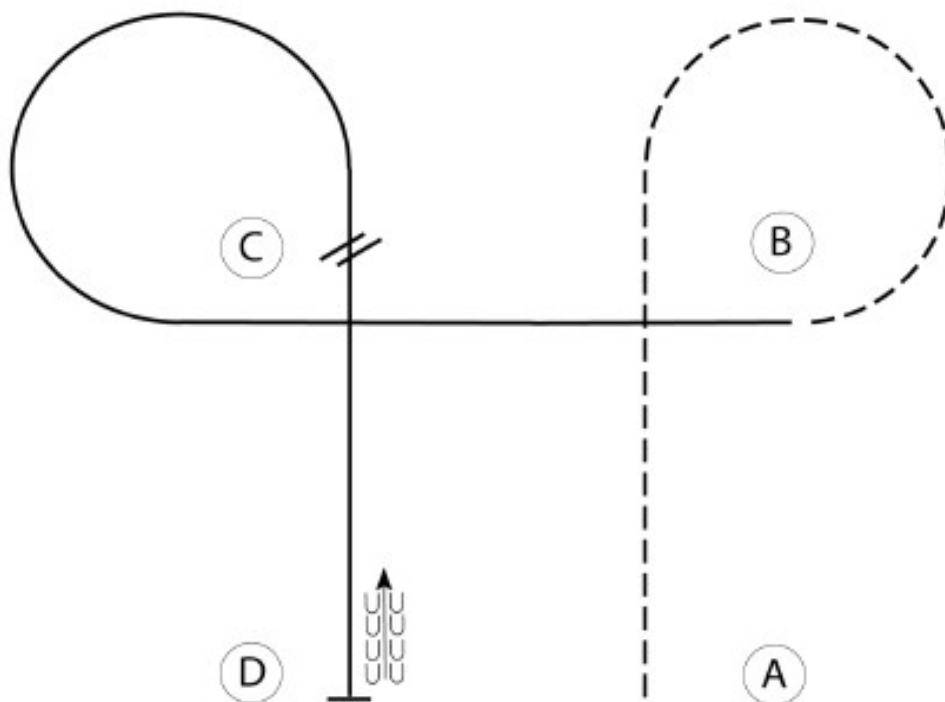

Be ready at A.

1. Jog A to B.
2. Jog a circle around B.
3. At B, lope on the right lead to C.
4. Lope a circle around C.
5. At C, perform a simple lead change and continue to D.
6. At D, stop and back one horse length.

Follow the instructions of your ring steward.

Walk	-----
Jog	-----
Extended Jog	-----
Lope	-----
Leg Yield	
Lead Change	↘
Back	← ← ←
Marker	(B)
Sidepass	←-----→

## Hunt Seat Equitation Open

All Breed

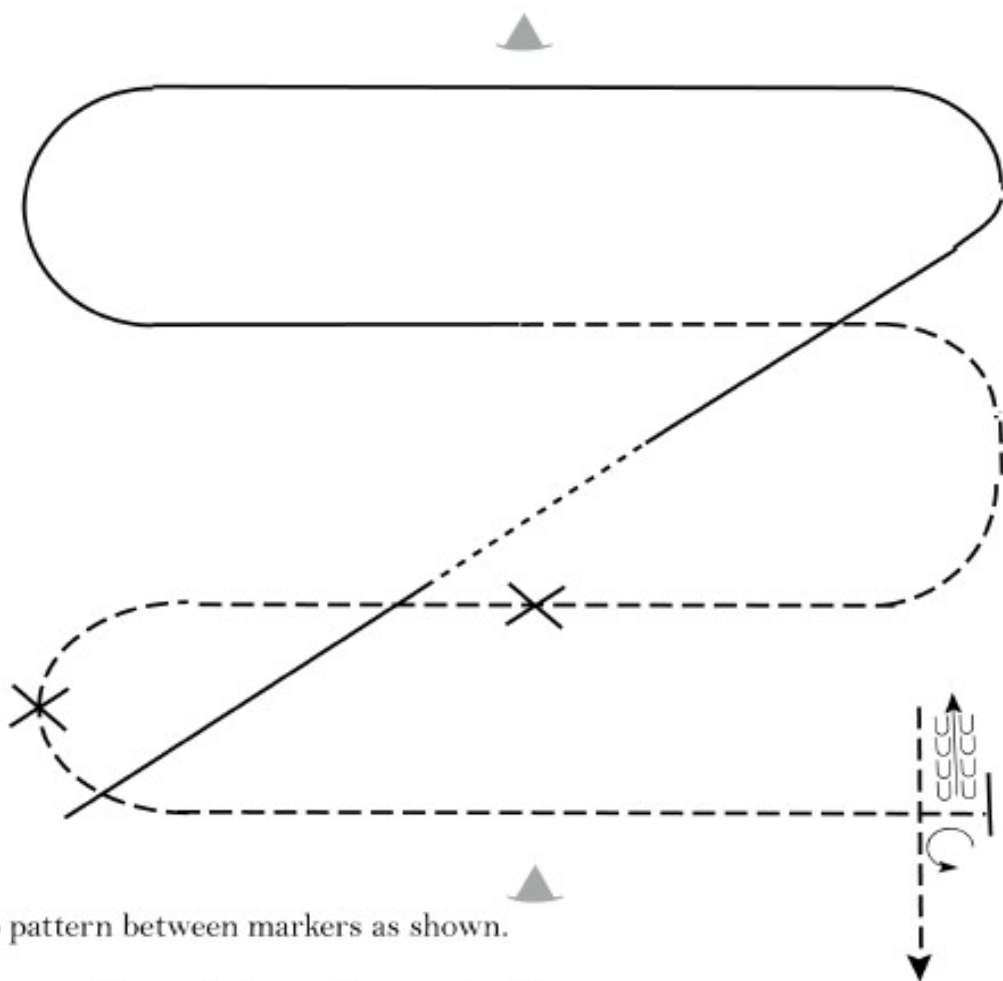

Keep pattern between markers as shown.

1. Canter right lead then walk several strides.
2. Canter left lead around to center of pattern.
3. Posting trot on the left diagonal then sitting trot (at X).
4. Posting trot on the right diagonal (at X).
5. Halt and perform a 3/4 turn on the forehand left.
6. Back approximately 2 horse lengths then exit at a trot.

Walk	-----
Trot	- - - - -
Extended Trot	-----
Canter	-----
Leg Yield	
Lead Change	↙
Back	←←←←←
Marker	(B)
Sidepass	←←←←←
Hand Gallop	-----

## Trail Youth & Amateur

AQHA & All Breed

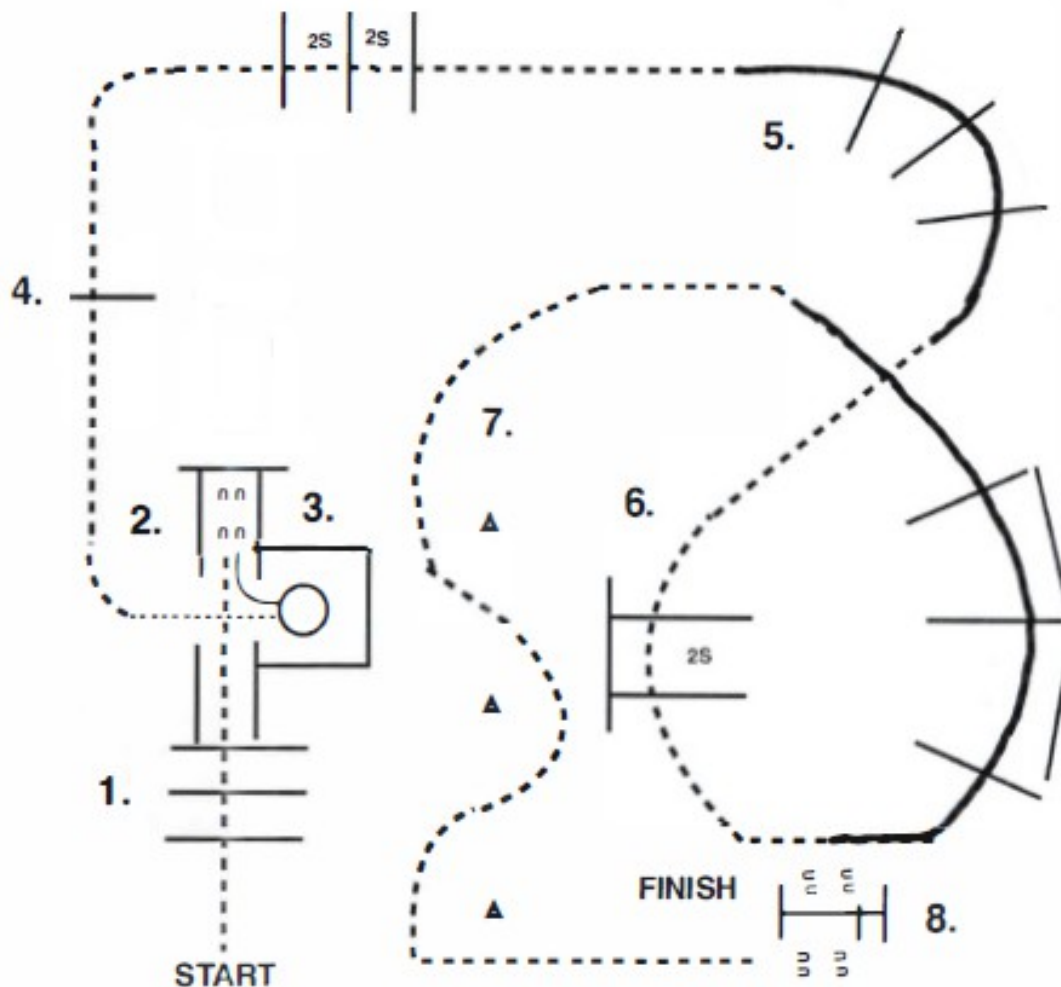

1. JOG OVER POLES, JOG INTO CHUTE.
2. BACK AROUND CORNER INTO BOX.
3. EXECUTE A 360 TURN RIGHT, THEN WALK OUT BOX.
4. JOG OVER POLES.
5. LOPE OVER POLES (RIGHT LEAD), BREAK TO JOG.
6. JOG OVER POLES AND LOPE OVER LEFT LEAD.
7. BREAK TO A JOG, JOG TRHU SERPENTINE.
8. JOG UP TO GATE: LH OPEN, WALK THRU AND CLOSE GATE.

## Trail Open

AQHA & All Breed

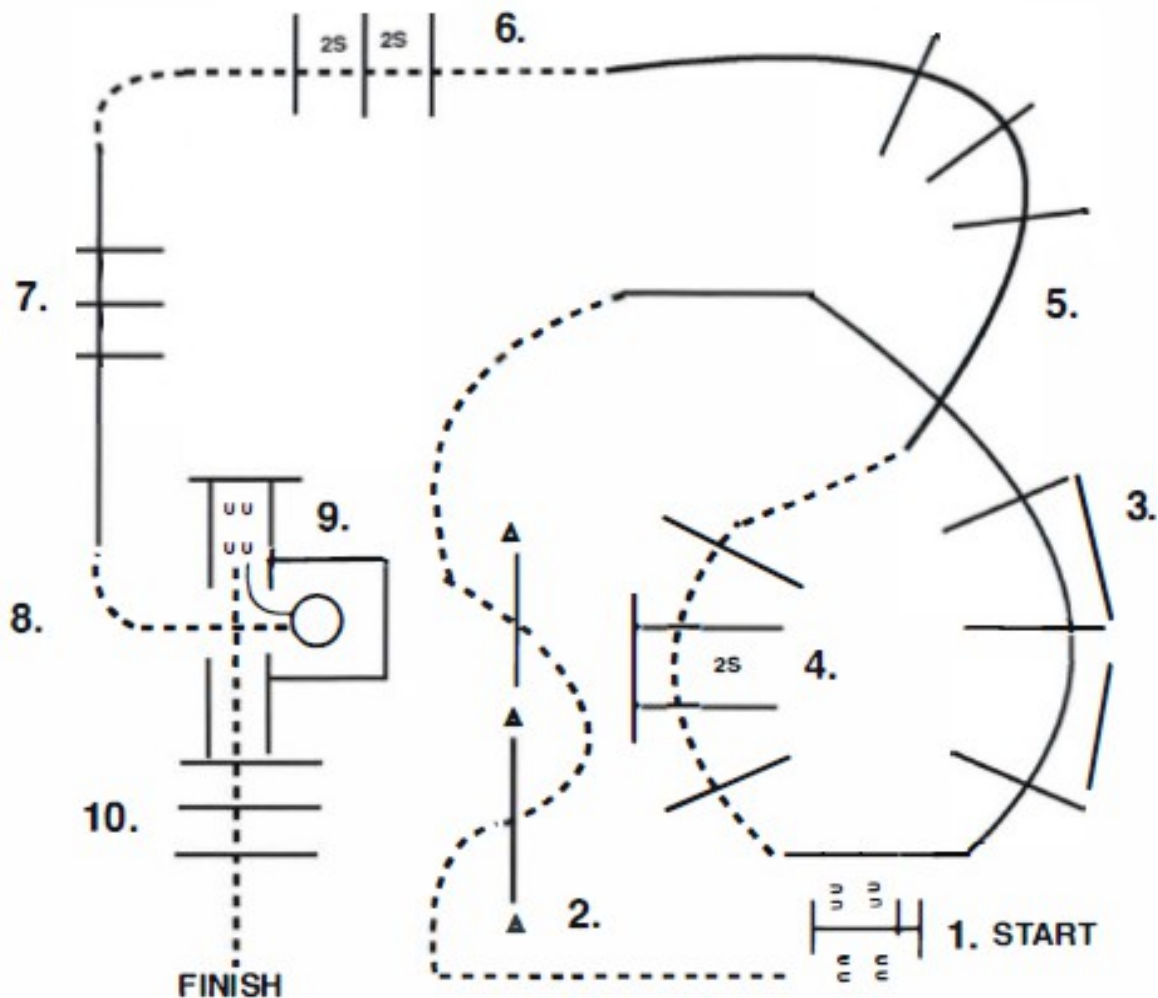

1. GATE: RIGHT HAND OPEN, WALK THRU AND CLOSE GATE.
2. YOU MAY WALK FORWARD, THEN JOG THRU SERPENTINE, AND JOG OVER POLES.
3. LOPE OVER POLES (RIGHT LEAD).
4. BREAK TO THE JOG, JOG OVER POLES.
5. LOPE OVER POLES (LEFT LEAD).
6. BREAK TO THE JOG, JOG OVER POLES.
7. LOPE OVER POLES (LEFT LEAD).
8. BREAK TO THE JOG, JOG INTO BOX, EXECUTE A 360 TURN EITHER WAY.
9. BACK OUT BOX, BACK AROUND CORNER.
10. JOG OUT CHUTE, JOG OVER POLES.